

SHO 4222- \_\_\_\_\_ - \_\_\_\_\_ - \_\_\_\_\_

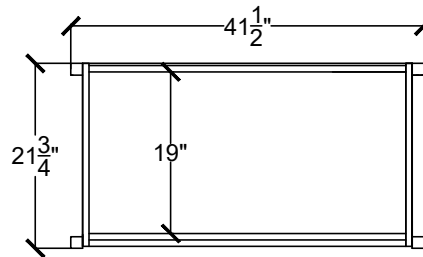

SHO 4222 2FF 2D- \_\_\_\_\_ - \_\_\_\_\_ - \_\_\_\_\_

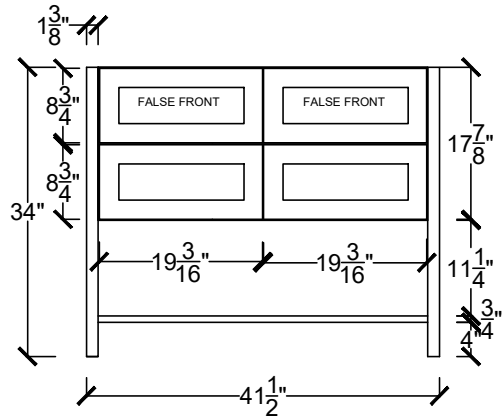
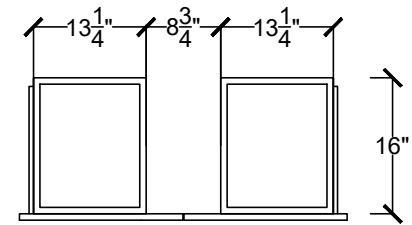

BOTTOM DRAWER BOX DETAIL

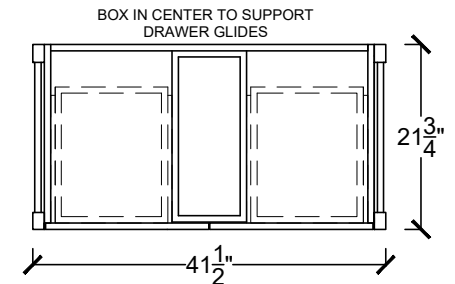

BOTTOM CABINET FLOOR DETAIL

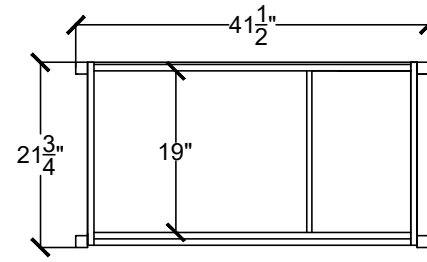
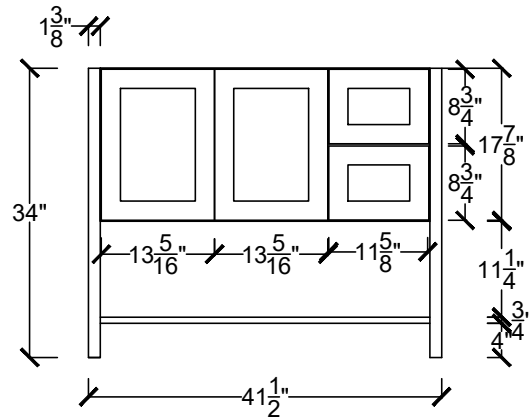

SHO 4222 2D R OR L - \_\_\_\_\_ - \_\_\_\_\_ - \_\_\_\_\_

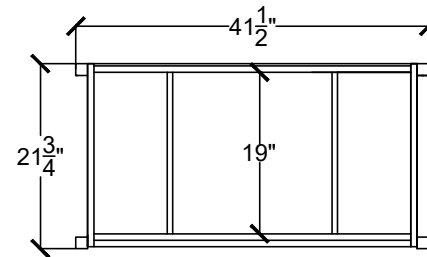
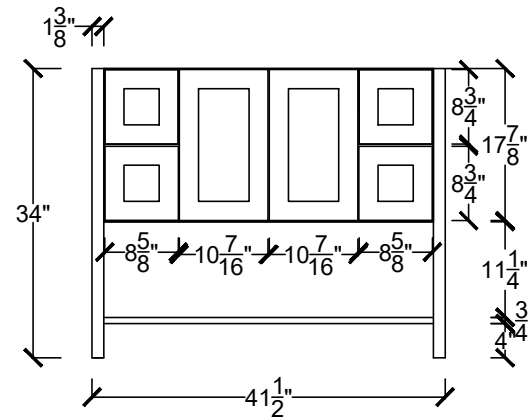

SHO 4222 4D R & L - \_\_\_\_\_ - \_\_\_\_\_ - \_\_\_\_\_