

SHO 3022-_____-_____-_____

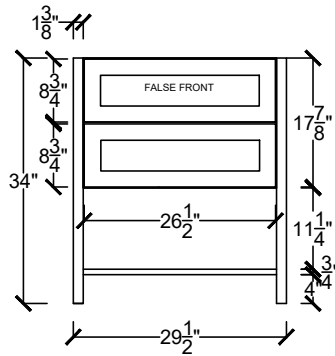

SHO 3022 1FF 1U-_____-_____-_____

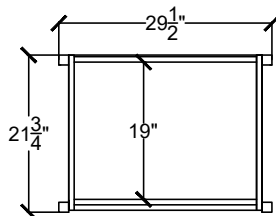
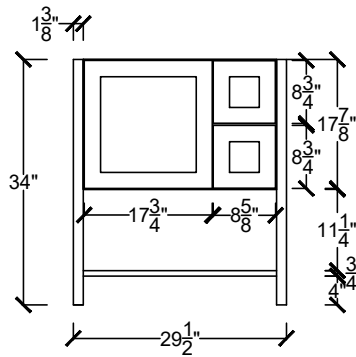
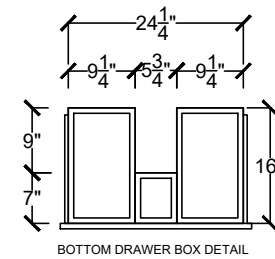
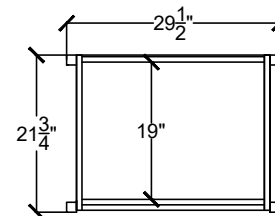

SHO 3022 2D R OR L -_____-_____-_____

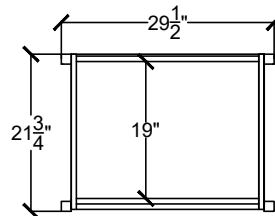

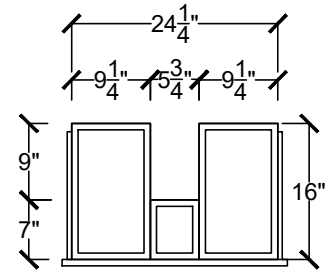
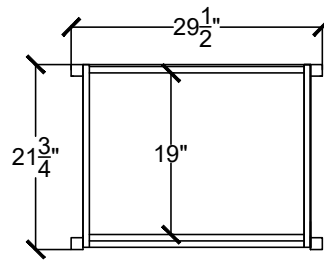
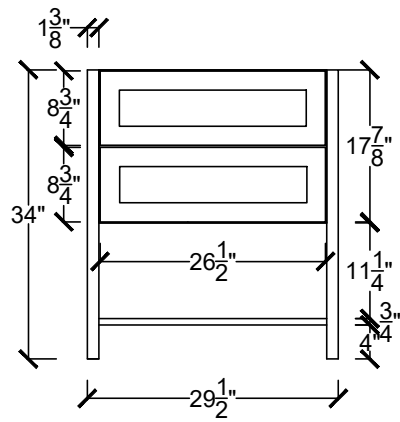

SHO 3022 2U- _____ - _____ - _____

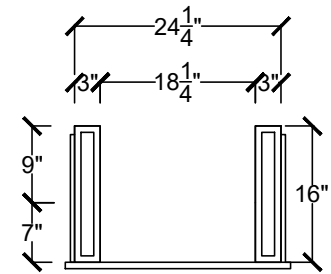
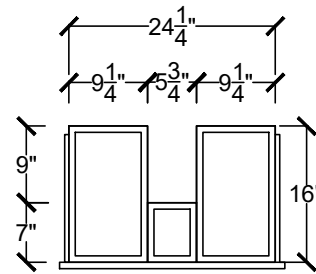
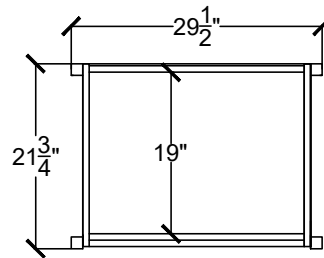
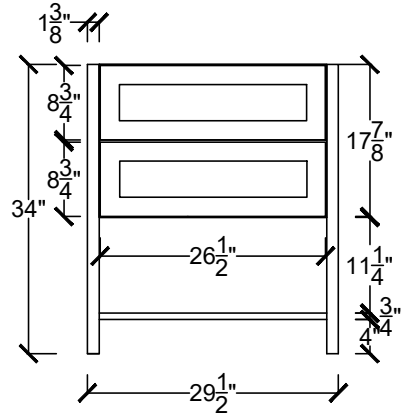

SHO 3022 2D 1U- _____ - _____ - _____