

VANITY CABINETS 42-54"

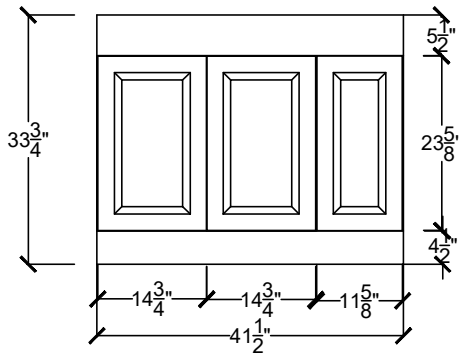

H-LINV 4222-\_\_\_\_\_-\_\_\_\_\_-\_\_\_\_\_

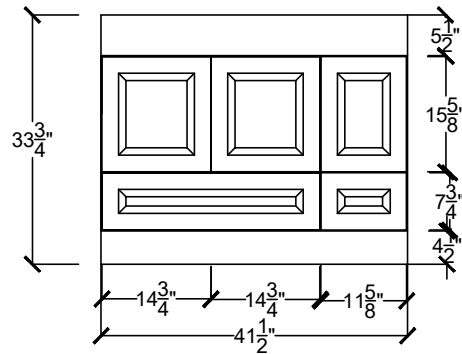

H-LINV 4222-BD\_\_\_\_\_-\_\_\_\_\_-\_\_\_\_\_

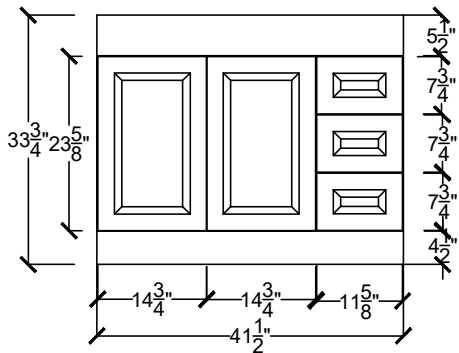

H-LINV 4222 3DL-\_\_\_\_\_-\_\_\_\_\_-\_\_\_\_\_  
OR  
H-LINV 4222 3DR-\_\_\_\_\_-\_\_\_\_\_-\_\_\_\_\_

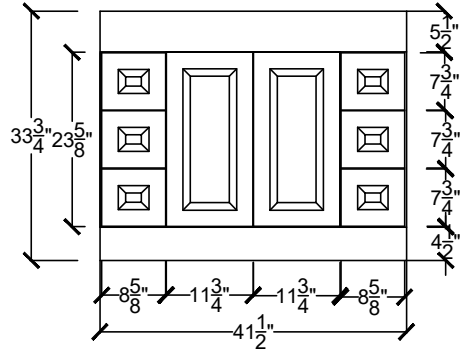

H-LINV 4222 6D-\_\_\_\_\_-\_\_\_\_\_-\_\_\_\_\_

VANITY CABINETS 42-54"

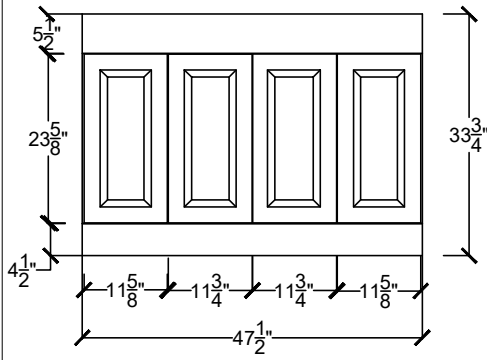

H-LINV 4822-\_\_\_\_-\_\_\_\_-\_\_\_\_  
 CENTER BOWL SINK

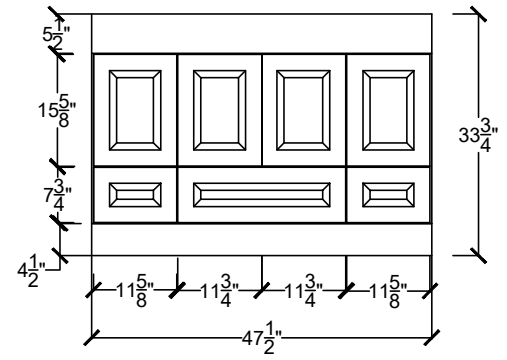

H-LINV 4822 BD-\_\_\_\_-\_\_\_\_-\_\_\_\_  
 CENTER BOWL SINK

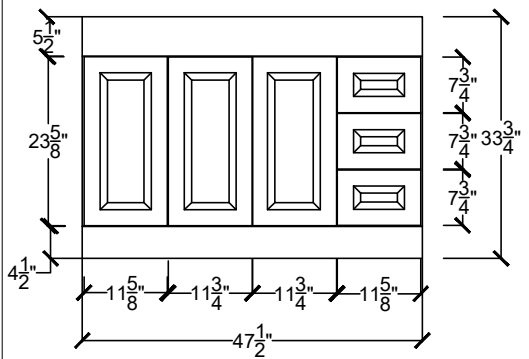

H-LINV 4822 3DL-\_\_\_\_-\_\_\_\_-\_\_\_\_  
 OR  
 H-LINV 4822 3DR-\_\_\_\_-\_\_\_\_-\_\_\_\_

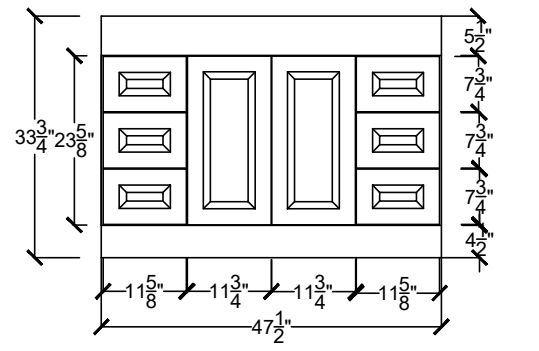

H-LINV 4822 6D-\_\_\_\_-\_\_\_\_-\_\_\_\_

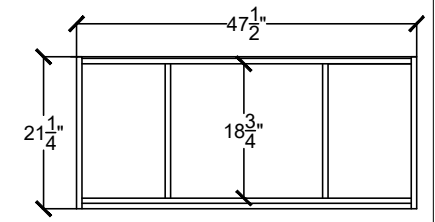
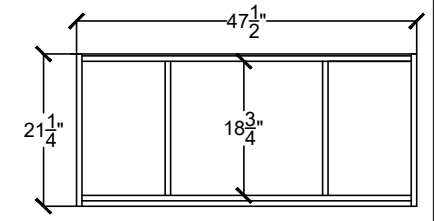

VANITY CABINETS 42-54"

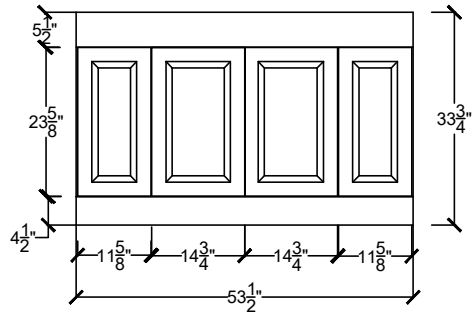

H-LINV 5422-\_\_\_\_-\_\_\_\_-\_\_\_\_  
CENTER BOWL SINK

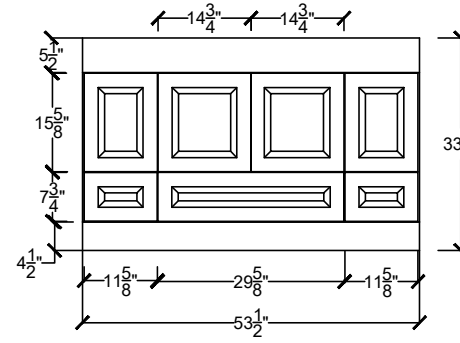

H-LINV 5422 BD-\_\_\_\_-\_\_\_\_-\_\_\_\_  
CENTER BOWL SINK

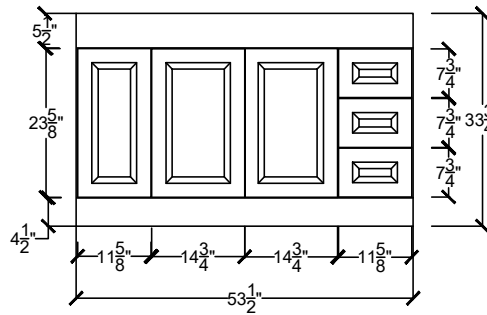

H-LINV 5422 3DL-\_\_\_\_-\_\_\_\_-\_\_\_\_  
OR  
H-LINV 5422 3DR-\_\_\_\_-\_\_\_\_-\_\_\_\_

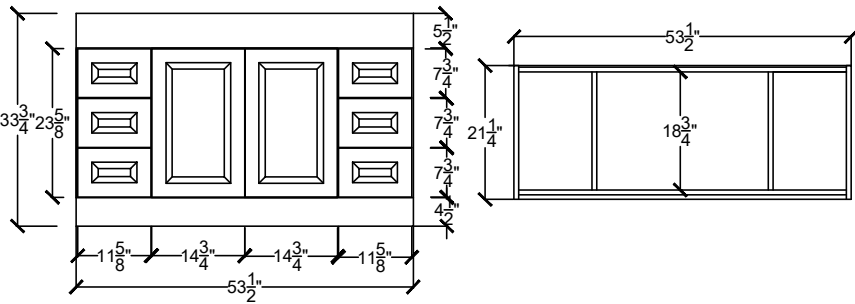

H-LINV 5422 6D-\_\_\_\_-\_\_\_\_-\_\_\_\_